

# Can mobile indoor air cleaners effectively reduce an indirect risk of SARS-CoV-2 infection by aerosols?

**Christian J. Kähler, Thomas Fuchs, Rainer Hain**

Universität der Bundeswehr München  
Institut für Strömungsmechanik und Aerodynamik  
Werner-Heisenberg-Weg 39  
85577 Neubiberg

## Abstract

The worldwide development of the SARS-CoV-2 infection makes it clear that the pandemic is only just beginning and cannot be stopped. Even if an effective and well-tolerated vaccine were available, it would not be feasible to vaccinate the world population on a large scale to combat the spread of the virus. It is therefore necessary to establish technical solutions to contain the pandemic at least locally. Mouth-and-nose-covers are now generally accepted technical aids to reduce the direct risk of infection when speaking, singing, coughing and sneezing. However, indirect infection via infectious aerosols, which accumulate over time in space, cannot be prevented with simple mouth-and-nose covers or surgical masks [5]. This requires tightly fitting particle-filtering respiratory masks. Alternatively, the aerosol concentration in the room can be reduced by means of filtration or discharged via window ventilation. Ventilation systems that reliably separate aerosol with a diameter smaller than 1  $\mu\text{m}$  are rare. The free ventilation by means of windows is often not efficient and at the latest in winter no longer possible without wasting energy and endangering the health and well-being of people. The question is therefore whether mobile indoor air cleaners are basically suitable for making a meaningful contribution to reducing the risk of infection? To answer this question, a TROTEC TAC V+ indoor air cleaner with a volume flow of up to 1500  $\text{m}^3/\text{h}$  was systematically analysed. The unit has a filter combination that ensures that 99.995% of aerosol with a diameter of 0.1 to 0.3  $\mu\text{m}$  is separated from the room air. The results show that the aerosol concentration in a room with a size of 80  $\text{m}^2$  can be reduced to a low level everywhere within a short time. In our opinion, indoor air cleaners with a large volume flow and high-quality filters of class H14 represent a very suitable technical solution to reduce the indirect risk of infection by aerosols in schools, offices, shops, waiting rooms, community and club houses, lounges and dining rooms, etc. However, they can also be used as a support in buildings with air conditioning systems where people stand together (waiting area) and work together or where a lot of aerosol is emitted due to the work load (fitness studio).

## 1. Introduction

According to the current state of research, SARS-CoV-2 is mainly transmitted via droplets that are produced when breathing, speaking, singing, coughing or sneezing and are inhaled and exhaled through the air we breathe [1, 2, 3, 4]. Direct infection, in which many emitted droplets

are inhaled over a short distance (less than 1.5 m) by an uninfected person, can be effectively prevented with the aid of particle-filtering respiratory masks (N95/KN95/FFP2 or better), as these respiratory masks reliably separate droplets up to a defined size class when inhaled and exhaled [5]. These respiratory masks therefore offer very good self-protection even without a safety distance. However, they also have the effect that the viruses emitted by infected persons hardly reach the air in the room. Therefore, in addition to self-protection, they also offer protection against direct and indirect infection if no outlet valve is integrated.

Larger droplets are also effectively separated by simple mouth-and-nose covers. Since larger droplets can statistically transport more viruses than small droplets, this effect is significant for processes that primarily produce large droplets (coughing, sneezing). The small droplets, however, are released into the outside air through gaps at the edge of the mouth-and-nose coverings, because these coverings do not close tightly enough to the face on the one hand and on the other hand the flow largely follows the path of least flow resistance [5]. However, due to the flow resistance of the mouth-and-nose-covering and the losses caused by the deflection, the small droplets remain in the vicinity of the head at first. This greatly limits the short-term spread of the droplets when speaking, singing, coughing or sneezing and thus the direct risk of infection is enormously reduced [5, 6, 7, 8, 9]. However, these coverings only provide effective protection if a safety distance (at least 1.5 m) can be maintained. Since the small droplets are released by these mouth-and-nose covers, they can accumulate in the room over time and lead to indirect infection even if the infected person is no longer in the room [8, 10].

Small droplets that hover in the air for hours and can be transported over long distances with the airflow are called aerosol particles and the mixture of air and aerosol particles is called an aerosol. It is scientifically proven that an aerosol loaded with infectious viruses can lead to COVID-19 infection as long as the liquid phase of the aerosol particles has not completely evaporated [11, 12]. The evaporation time of aqueous aerosols with a diameter of a few micrometers is less than one second at moderate humidity [6]. At high humidity, however, the evaporation rate can come into equilibrium with the condensation rate and then the liquid portion is permanently preserved. The probability of infection is then only limited by the half-life of the viruses. The SARS-CoV-2 half-life is 1.1–1.2 hours, i.e. after about an hour, statistically speaking, half of the viruses in a drop no longer present a risk of infection [11]. Whether aerosol particles are still infectious after evaporation of the liquid phase is currently the subject of controversial debate [13, 14, 15]. These solid particles consisting of salts, virus material and dried mucus are called droplet nuclei. Depending on the solid content, the droplet nuclei are much smaller than the original droplets from which they originated. In chapter 9 we will go into this in more detail. Due to their small size, the droplet nuclei also float in the air and therefore, even at low humidity, they form together with the air a long-lasting aerosol that can accumulate in space over time, provided that sources are present and it is not filtered or discharged.

Since the indirect probability of infection in a room increases with the number of infected persons their activity and the length of time the non-infected spend in the room, measures must be taken to limit the virus load in the room air. Which limit value should be aimed at in this context is currently not defined and it is also not clear how the SARS-CoV-2 concentration in the room should be measured at all. Many buildings have ventilation and air conditioning systems that ensure that contaminated air is removed in a controlled manner and filtered or

fresh air is added from outside. In regions with moderate climatic conditions, however, ventilation is usually provided by free ventilation through windows and doors. Recommended air exchange rates are based on CO<sub>2</sub> emissions and other human evaporation (e.g. water vapour), as well as the accumulation of pollutants in the room (e.g. radon) and the prevention of building damage (e.g. mould growth) [16]. As early as 1858, Max von Pettenkofer recognized that indoor CO<sub>2</sub> values of a maximum of 1000 ppm should be aimed for [17]. With a CO<sub>2</sub> ambient pollution of 450 ppm in cities, however, this value is often difficult to achieve [18]. For many areas, it is therefore recommended, irrespective of the CO<sub>2</sub> concentration, to supply a certain amount of fresh air per hour, which varies according to the use of the room. In offices, restaurants and sales rooms, up to 4 – 8 times the room volume should be supplied per hour in order to protect people and buildings from pollutants and to ensure the performance of people [18, 19]. If, however, pollutants are emitted into the room that pose a considerable risk to health, such as viruses, then, depending on the level of risk, considerably higher air exchange rates of 12 – 15 are necessary [20, 21, 22].

The main advantage of heating, ventilation and air conditioning (HVAC) systems over free ventilation is that they continuously provide adequate indoor air quality and regular manual regulation by means of windows is not necessary, see Figure 1 (left). However, they must be maintained regularly and operated correctly. For energy reasons, they are often operated with only a small supply of fresh air and simple filters. To prevent indirect infections, however, a sufficient supply of fresh air or very good filtering of the room air is required [23]. Due to the mild climatic conditions in many regions, fresh air is often supplied through windows with the help of free ventilation. With impulse ventilation, the existing pollutant concentration in the room can be greatly reduced within a short time under suitable wind conditions or temperature differences, but after closing the windows the pollutant concentration gradually increases again, as shown schematically in Figure 1 (right).

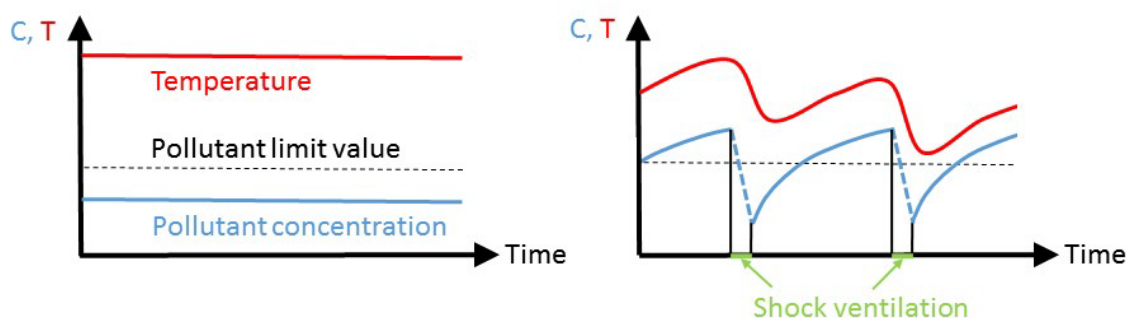

*Figure 1: Schematic representation of the pollutant concentration and the temperature curve in a room with HVAC system (left) and shock ventilation (right)*

In order to keep the pollutant concentration at a low level, it is therefore often necessary to provide shock ventilation or, better, permanent ventilation. Cross-ventilation is most effective in suitable weather conditions, but it can also quickly be perceived as unpleasant. A tilted window, on the other hand, usually does not lead to any significant exchange of air in the room [16]. Under these conditions, it is recommended to open two windows and to place a fan in front of one window to bring fresh air into the room from outside. Due to the increase in pressure, the contaminated air is then discharged through the other window. With this method, all areas of the room are supplied with fresh air and the dwell time of the aerosol in the room can be kept short, which reduces the indirect infection risk. In the cold season, however, free

ventilation is not only uncomfortable, but it also endangers health. Furthermore, free ventilation is energetically poor and not possible in windowless rooms. Furthermore, the efficiency of air exchange during free ventilation depends on parameters that cannot be influenced, such as the position and size of windows, the speed and direction of the wind in front of the windows, the difference in temperature between inside and outside, and people's willingness to ventilate [24, 25].

It is difficult to determine which type of ventilation offers the best protection against indirect SARS-CoV-2 infection, since the number of viruses emitted or the virus concentration and thus the probability of infection in a room is not known. Since there is also no correlation between virus concentration and other variables such as CO<sub>2</sub> concentration, the virus load cannot be measured indirectly via the CO<sub>2</sub> content. For this reason, the highest possible air exchange rates should be aimed for in order to minimize the probability of infection. Due to the deadly danger of a SARS-CoV-2 infection, it is certainly reasonable not to fall below the air exchange rates already recommended without risk of infection, but to exceed them.

It is foreseeable that in the current pandemic, additional challenges will arise in winter at the latest in order to minimise the risk of infection in enclosed spaces. However, even the currently discussed opening of schools without maintaining safety distances and without using mouth-and-nose covers or particle-filtering respirators is viewed with concern by many people, as there is a possibility that children will become infected among themselves and the chain of infection will then run through their parents and grandparents. As COVID-19 mortality increases with age, this concern of many parents is well founded and justified. It is therefore a question of whether the viral load can be effectively minimized in buildings without HVAC systems with class H13/H14 filters or 100% fresh air supply without reducing comfort or accepting acute damage to health.

It is necessary to find a solution that on the one hand does not cause rapid air movements or large fluctuations in temperature or humidity in the room, which would impair comfort [26], and on the other hand efficiently filters out the aerosol particles contaminated with infectious virus material without distributing them uncontrollably like a "virus slingshot" [4]. To ensure this, a sufficient air exchange rate is important and the residence time of the emitted aerosols must be as short as possible. The air exchange rate does not mean that the air is completely exchanged, as in an air pump, but rather the proportion of fresh or purified air supplied per hour in relation to the room volume [24]. On the other hand, the air speed and the turbulent fluctuating movement of the air must not be too great, otherwise it can become unpleasant for the people in the room, depending on their clothing and activities. Figure 2 illustrates the dependence of comfort on the average air velocity, the turbulent air fluctuations and the temperature according to [26]. The areas below the respective curve can be regarded as comfortable. As a guide value, it is usually required that at moderate room temperatures the air velocity should be less than 0.3 m/s on average over long periods of time.

The flow movement in space is therefore very important to consider and can be strongly influenced by fixtures (lamps) or large objects in the room, but also by openings in the walls (draught) or the movement of people (mixing, thermal convection) [24, 25]. Therefore, the correct positioning of a room air cleaner is important for efficient filtering of the aerosol particles in a room with mobile devices. But also the position where the aerosol particles are emitted locally plays a major role. Further influencing parameters are the emitted aerosol particle concentration depending on the activity as well as the dwell time in the room.

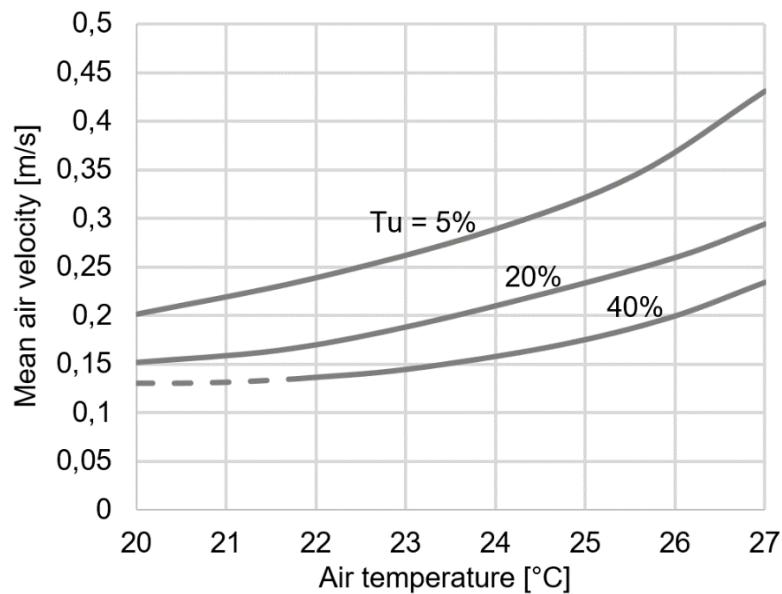

Figure 2: Areas with comfortable air velocity according to [26]

Due to the complexity of the flow problem, an experimental approach is used within the scope of these investigations, since only in this way the many influencing factors can be recorded physically correctly.

A TROTEC TAC V+ room air cleaner with the following features was used for the experimental investigations [27]:

1. A maximum volume flow rate of about 1500 m<sup>3</sup>/h.
2. Class F7 and H14 filters. H14 means that 99.995% of aerosols with a diameter of 0.1 to 0.3  $\mu\text{m}$  are separated. Larger particles are separated to 100%.
3. The filter can be heated to over 100°C after use to destroy the viruses in the filter and to counteract the formation of biofilms, bacteria and fungi without harmful chemical additives or UV-C radiation.
4. Despite its weight, the device can be easily moved, so that it can be used in various areas without any problems.

## 2. Experimental setup and PIV experiments

The aim of the first series of tests was to quantify the intake and blow-out characteristics of the indoor air cleaner at different performance levels / volume flow rates. According to Figure 2, the average air velocity and the turbulent air fluctuations in the environment of the indoor air cleaner must be quantitatively recorded for this purpose. These variables are important to determine whether the air movement is perceived as disturbing by people in the vicinity. Air velocities in the range of less than 0.3 m/s are usually not considered disturbing if the persons are only engaged in light activities. Since the air movement felt is composed of the average and turbulent flow movement, the sum of both components must be less than 0.3 m/s on average. Particle Image Velocimetry (PIV) was used to determine these two quantities in relation to the distance to the device [28]. In this measurement technique, the movement of artificially generated aerosol particles, which follow the air movement exactly, is registered in a laser light-sheet with digital cameras at two instants in time and then the displacement of the particle images is determined using digital image processing methods. From the displacement

of the particle images, the spatially resolved velocity distribution in the measuring plane can then be determined without contact, taking into account the time interval between the measurements and a calibration. Figure 3 shows pictures of the test setup and during a measurement.

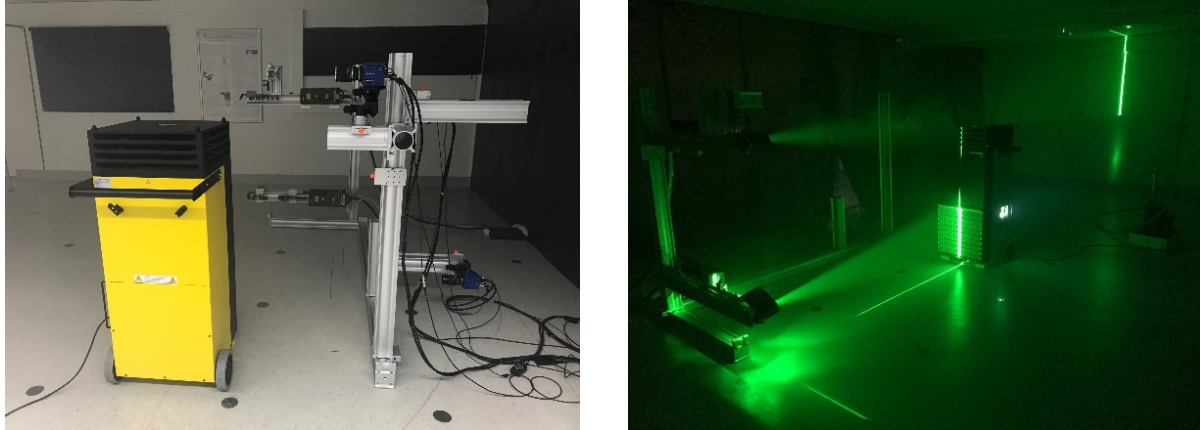

*Figure 3: Experimental setup with indoor air cleaner, two double pulse lasers and 4 sCMOS cameras (left) and recording during measurement with PIV (right)*

For the experiments 4 PCO.edge 5.5 sCMOS cameras with Zeiss macro lenses with focal lengths of 35 mm and 50 mm were used. The aerosol particles were generated from di-2-ethylhexyl sebacate (DEHS) with a seeding generator from the company PIVTEC. The average diameter of the aerosol particles is 1  $\mu\text{m}$  and the size distribution is between 0.1 – 2  $\mu\text{m}$  [29]. For the PIV flow experiments in chapter 6 helium filled bubbles with an average diameter of about 350  $\mu\text{m}$  were used, which were generated with an HFSB generator from LaVision. Two Quantel Evergreen 200 lasers were used to illuminate the particles, whose beams were formed into light-sheets using different lenses [28]. The measuring system was controlled by the software DaVis from LaVision GmbH, which was also used for data evaluation.

### **3. Characterisation of the flow field in the vicinity of the air purifier**

Figures 4 – 9 show the results of measurements at volume flows of 600  $\text{m}^3/\text{h}$ , 1000  $\text{m}^3/\text{h}$  and 1500  $\text{m}^3/\text{h}$ . In the upper figure, the velocity magnitude is colour-coded and the direction of the average flow velocity is shown as vectors. In the lower figure, the amount of turbulent air movement is shown. The quantitative measurement results show that the mean flow velocity and the turbulent motion in the vicinity of the device do not exceed the critical values shown in Figure 2. Therefore, even if you stay in the immediate vicinity of the air purifier, no impairment of your well-being by air movements is to be expected. At a volume flow of 1500  $\text{m}^3/\text{h}$ , slightly higher flow speeds are achieved in front of the intake area, but only in the leg area and only up to a distance of approx. 0.5 m in front of the unit. In the sensitive head and body area, the average flow velocities and turbulent air movement are significantly lower than 0.3 m/s. Directly in the outflow area and above the head of the device, considerably higher flow speeds are achieved. At a distance of 0.5 m from the unit, however, these are not noticeable even when the unit is standing, as the emerging free jet is directed strongly upwards by baffle plates. It is therefore hardly possible to block the outlet jet, which could lead to an impairment of the filter effect in the room. As a result, it can be stated that the air velocities comply with the guidelines due to the operation of the room air cleaner.

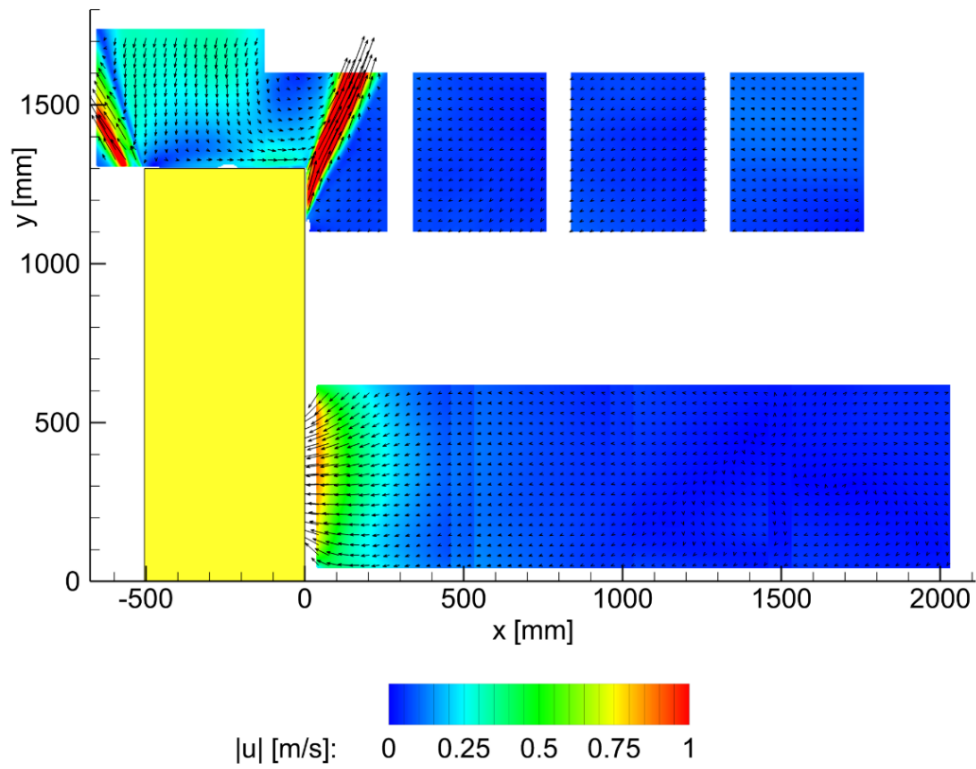

Figure 4: Average flow field measured at 600 m<sup>3</sup>/h.

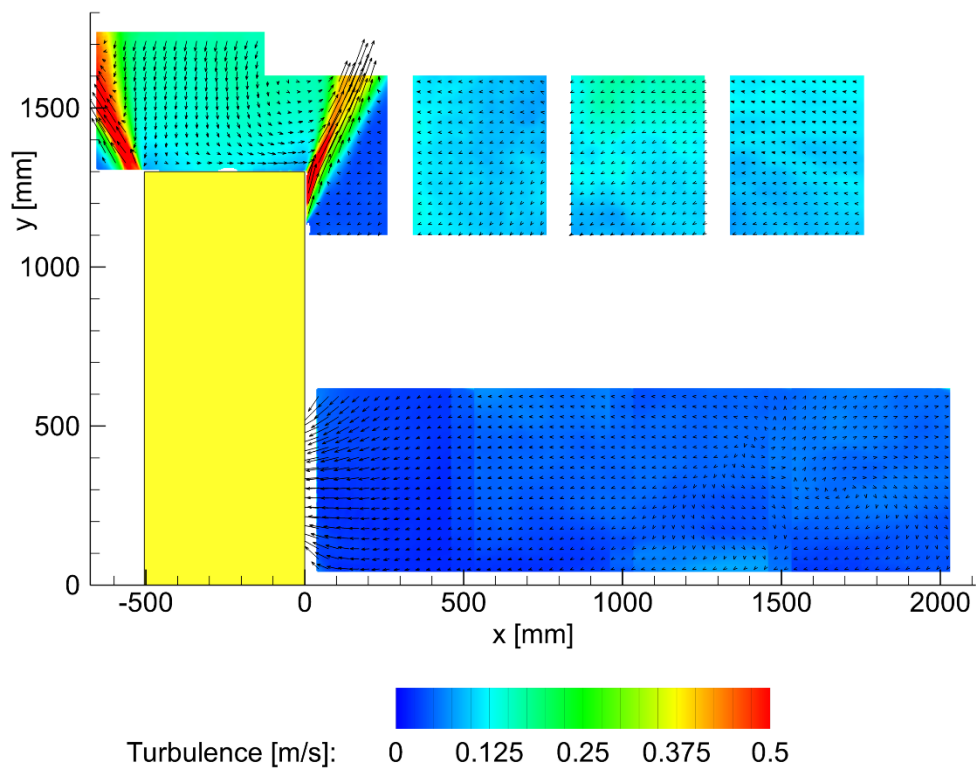

Figure 5: Turbulent flow movement averaged over time at 600 m<sup>3</sup>/h.

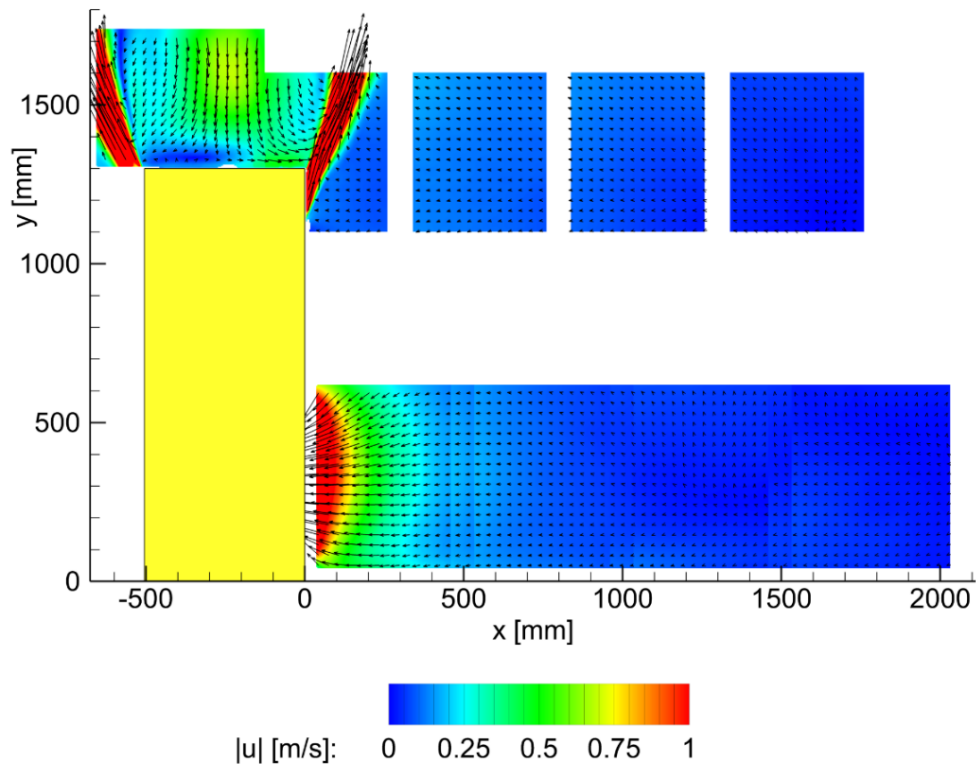

Figure 6: Average flow field measured at 1000 m<sup>3</sup>/h.

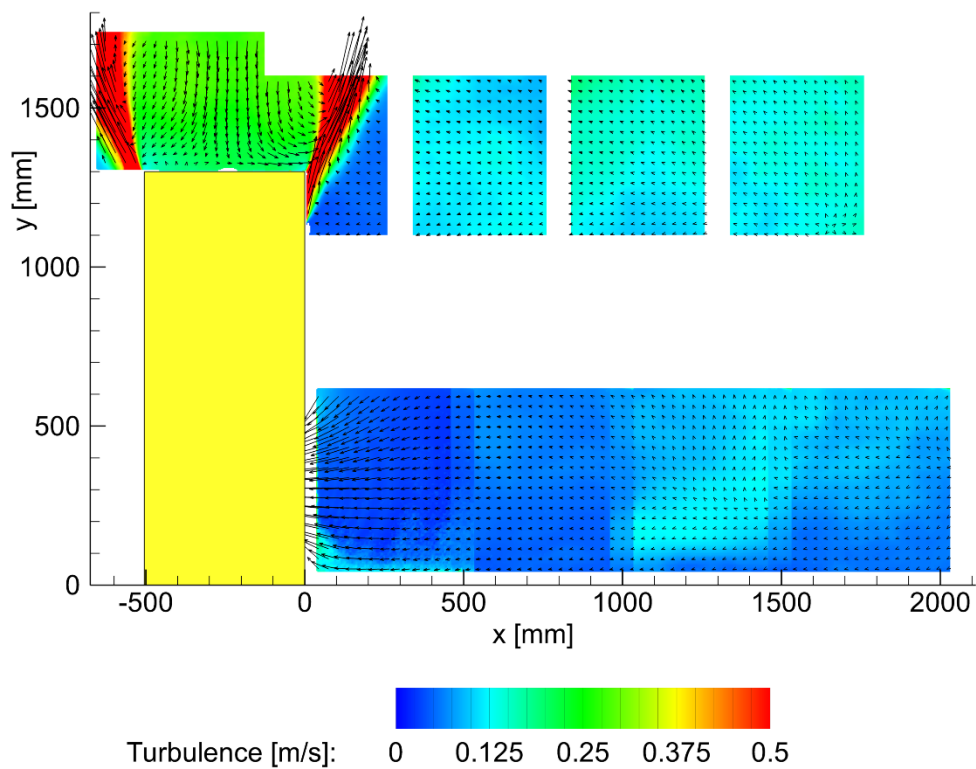

Figure 7: Turbulent flow movement averaged over time at 1000 m<sup>3</sup>/h.



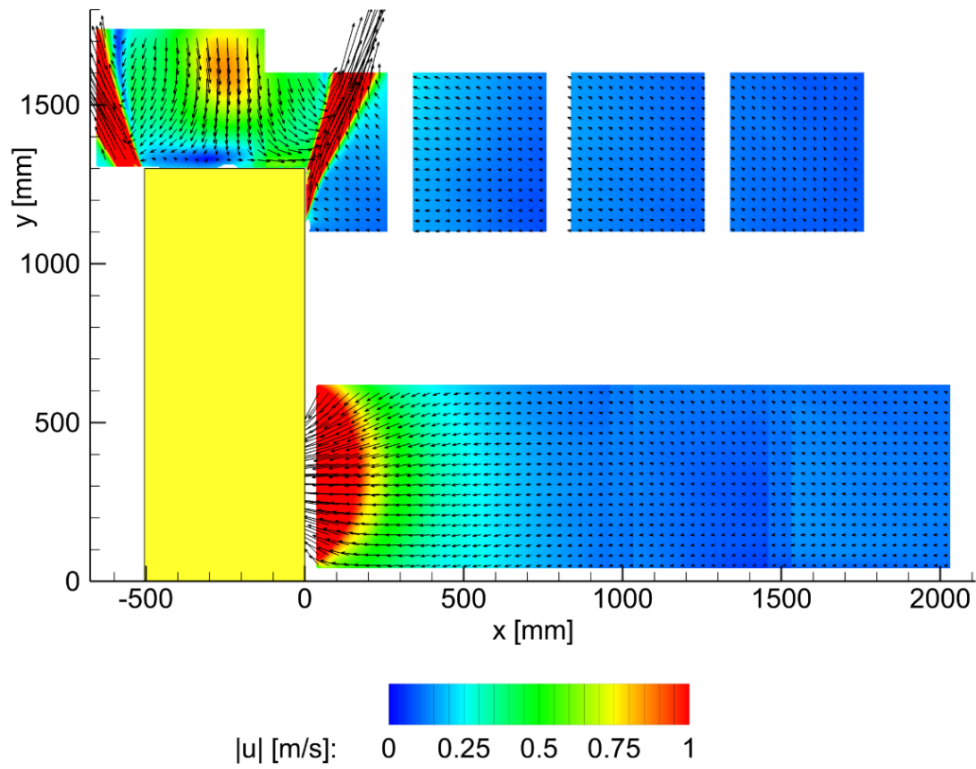

Figure 8: Average flow field measured at  $1500 \text{ m}^3/\text{h}$ .

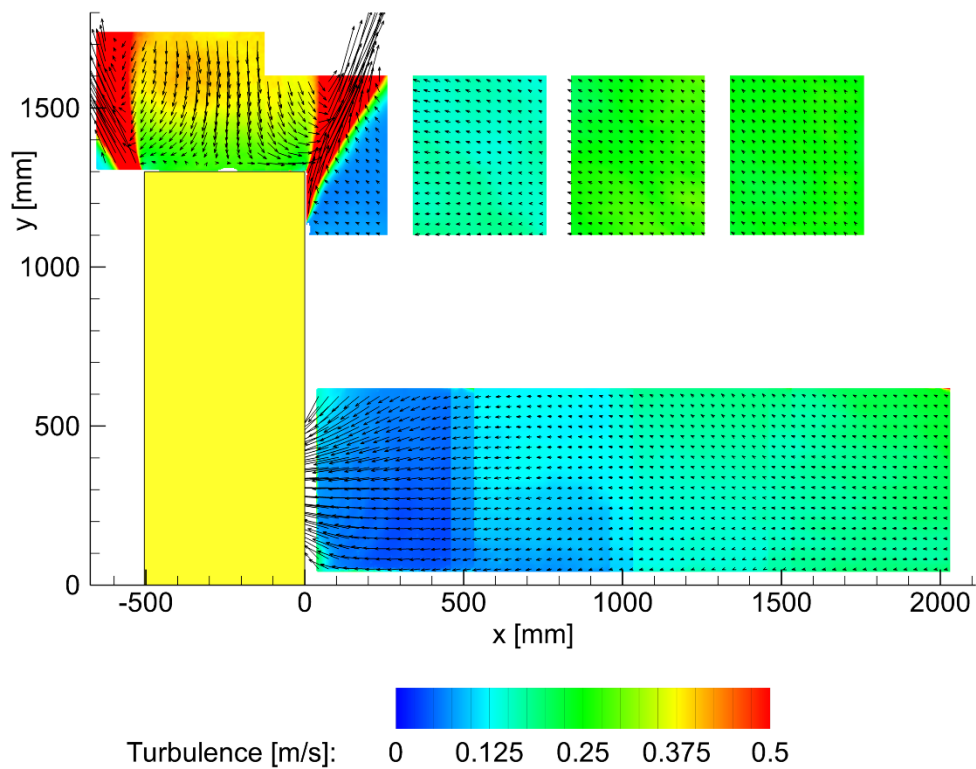

Figure 9: Turbulent flow movement averaged over time at  $1500 \text{ m}^3/\text{h}$ .

#### 4. Flow effects through objects

An independent study has already shown that the filter effect can depend on the location of the device and objects in the room [30]. To determine the extent to which positioning the room air purifier close to a wall and long ceiling lamps can adversely affect the flow movement in the room and thus possibly delay the time for filtering the room air, the room air purifier was positioned close to a wall and the outlet jet was blocked by room-dividing ceiling lamps. The velocity distribution shown in Figure 10 illustrates that the discharged air first rises to the ceiling and is then deflected at the ceiling. Due to the Coandă effect, the outlet jet is following the ceiling and spreads out as a so-called wall jet. Due to the protruding ceiling lamps, which run along the entire length of the room, the flow is again deflected and consequently a large vortex is formed. These local vortices reduce the filtering performance in the room, as the filtered air is partly returned to the unit and filtered again before sufficient entrainment of viruses in the room can take place [24]. Such constellations should therefore be avoided as far as possible by suitable positioning of the unit in the room.

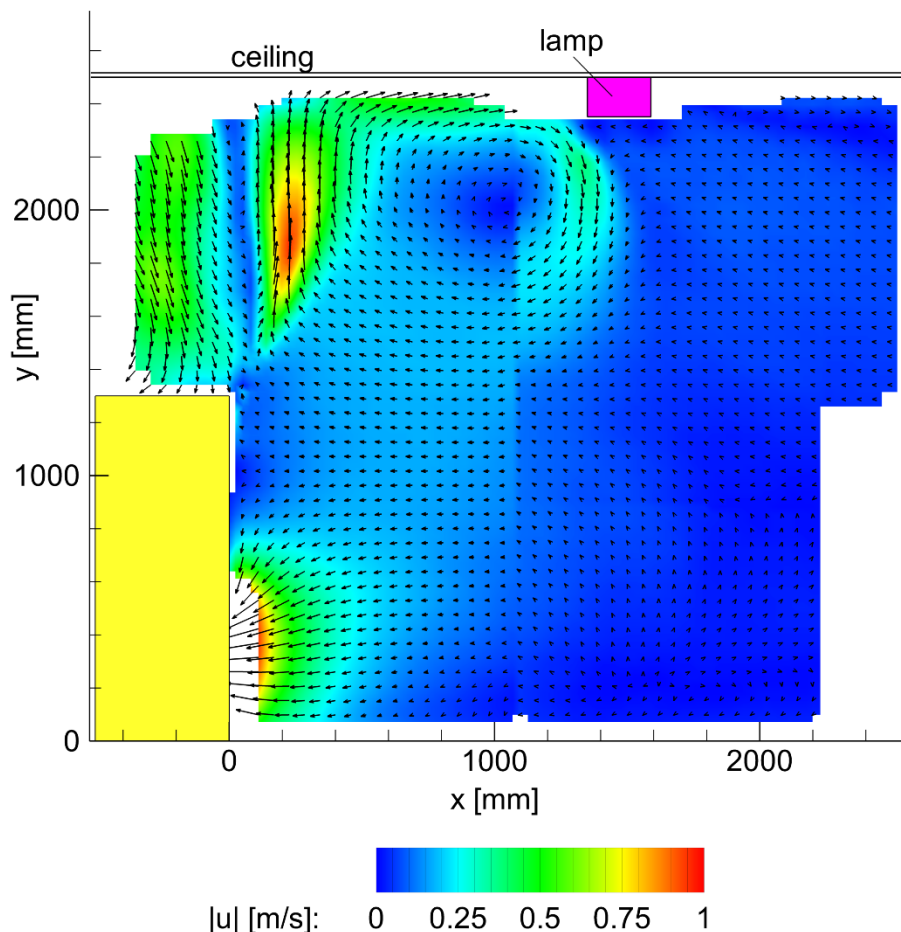
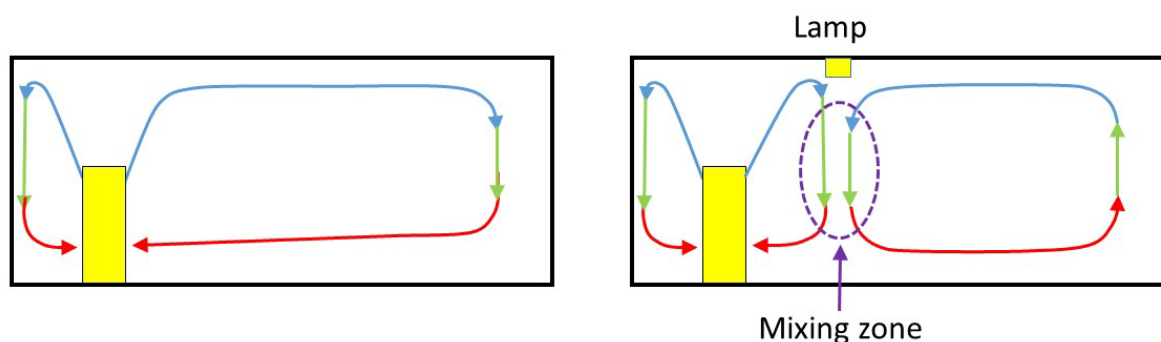

Figure 10: Measured room air flow in front of the room air cleaner with interrupted ceiling

In order to enable effective filtering of the room air, it is recommended that the room air cleaner is positioned in the middle of the longest side of the room if possible, and that it is ensured that the air jets hitting the ceiling can flow along the ceiling undisturbed for as long as possible. If the ceiling is smooth and the room is not too large, the jet can flow to the other side wall. There it is deflected downwards and flows along the floor back to the intake area of the purifier, as

shown schematically in figure 11 (left). In this way, the best possible air exchange is ensured, as the contaminated air areas in the room are continuously transported to the unit via a few large vortex flows. If the air flow on the ceiling is interrupted, e.g. by a lamp, a flow movement as shown in Figure 11 (right) can be expected, provided the room is sufficiently large.



*Figure 11: Simplified schematic representation of the room air flow in an empty room (left) and in the presence of a row of lamps on the ceiling (right). In reality, the flow phenomena are three-dimensional.*

The obstruction of the air flow at the ceiling can also be caused by a high heat source (heating, stove, group of people) in the room. Heat sources cause the density of the air to decrease and due to the reduced density it becomes lighter than the ambient air and therefore it is moved upwards by the heavier air masses at the bottom and rises. This thermal convection flow then reaches the ceiling where it is deflected in all directions. This flow can therefore counteract the flow movement generated by the fan and lead to the flow separation of the wall jet at the ceiling. In this case, a vortex can again form which does not cover the entire room, and the filter performance can thus be reduced, analogous to the schematic representation in Figure 11 (right). It should be noted, however, that the turbulent air movement in the room will always ensure that all the air in the room enters the fan's area of influence after a certain time and the aerosol is then separated. However, the aim should be to keep the time for filtering the room air as short as possible.

## 5. Experimental design and performance of concentration measurements

With the aim of quantitatively determining the filter performance of the room air purifier, concentration measurements were carried out simultaneously at six positions in the 80 m<sup>2</sup> room. The particle imaging method was used to determine the decay rates of the aerosol concentration in the room air. For this purpose, the room was first nebulized homogeneously and at high concentration with very long-lived aerosol particles whose size distribution corresponds to the aerosol emitted when breathing, speaking and singing. The longevity of the aerosol particles is very important, as otherwise the measurement results would be falsified by evaporation. Furthermore, the small size is important because otherwise the aerosol particles would settle over time, which would also cause systematic measurement errors. The aerosol particles are illuminated by a pulsed laser and imaged by a camera with a suitable lens and stored for further processing. The number of particle images on the sensor corresponds to the number of aerosol particles in the illuminated volume. The number on the sensor must not be too high as overlapping particle images would systematically falsify the count. For this reason, the imaging scale of the optical system must be adapted to the initial concentration of the aerosol particles. To detect the particle images, digital filters are used to suppress the noise, and then the background is removed by means of an intensity threshold. As a result of this

image pre-processing, only the aerosol particle images remain on the image, which are then counted. Without this image pre-processing, stochastic image noise could be misinterpreted as a signal, which would lead to systematic measurement errors. By taking images at a fixed frequency over a sufficiently long period of time, the individual aerosol particle images can be reliably counted in each individual image. The result of the measurements is the number in the measurement volume over time, from which parameters such as the decay rate, half-life etc. can be determined.

To analyse the functionality of the TROTEC TAC V+ room air purifier in an 80 square metre room, the aerosol particle concentration was measured simultaneously at 6 independent locations in the room. For reasons of symmetry, the concentration was only determined on the axis of symmetry of the room and in one half of the room. With a PIVTEC seeding generator the aerosol particles with a size distribution between 0.1–2  $\mu\text{m}$  and a mean diameter of about 1  $\mu\text{m}$  was generated from Di-2-ethylhexyl-sebacate (DEHS) [19]. For recording the aerosol 6 PCO.edge 5.5 sCMOS cameras with Zeiss macro lenses with a focal length of 50 mm were used. For the illumination of the aerosol particles in the measuring volume, 2 Quantel Evergreen 200 lasers were used, whereby the lasers were set up in such a way that 3 measuring points (cameras) each share a laser beam to illuminate the local measuring volume (MP1 – MP3 and MP4 – MP6). The individual cameras and lasers were centrally controlled by LaVision's DAVIS software so that the recordings of all 6 cameras were performed synchronously. The recording rate was 1 Hz.

Figure 12 shows the optically distorted panoramic image of the test setup in the room and Figure 13 shows the geometry and dimensions of the room as well as the positions of the device and the six measuring points in top view. Two instrument positions were chosen. Position A can be regarded as a quasi optimal position. A position in the middle of the room would be even more advantageous with regard to the filter efficiency according to Figure 11, but a central installation position will rarely be realized in practice. Position B indicates the most unfavourable position in the room, as the installation in the corner of the room and the lamps on the ceiling will prevent an optimal indoor air flow, according to Figure 10.



*Figure 12: Optically distorted panoramic image of the test chamber with the components for the concentration measurements*

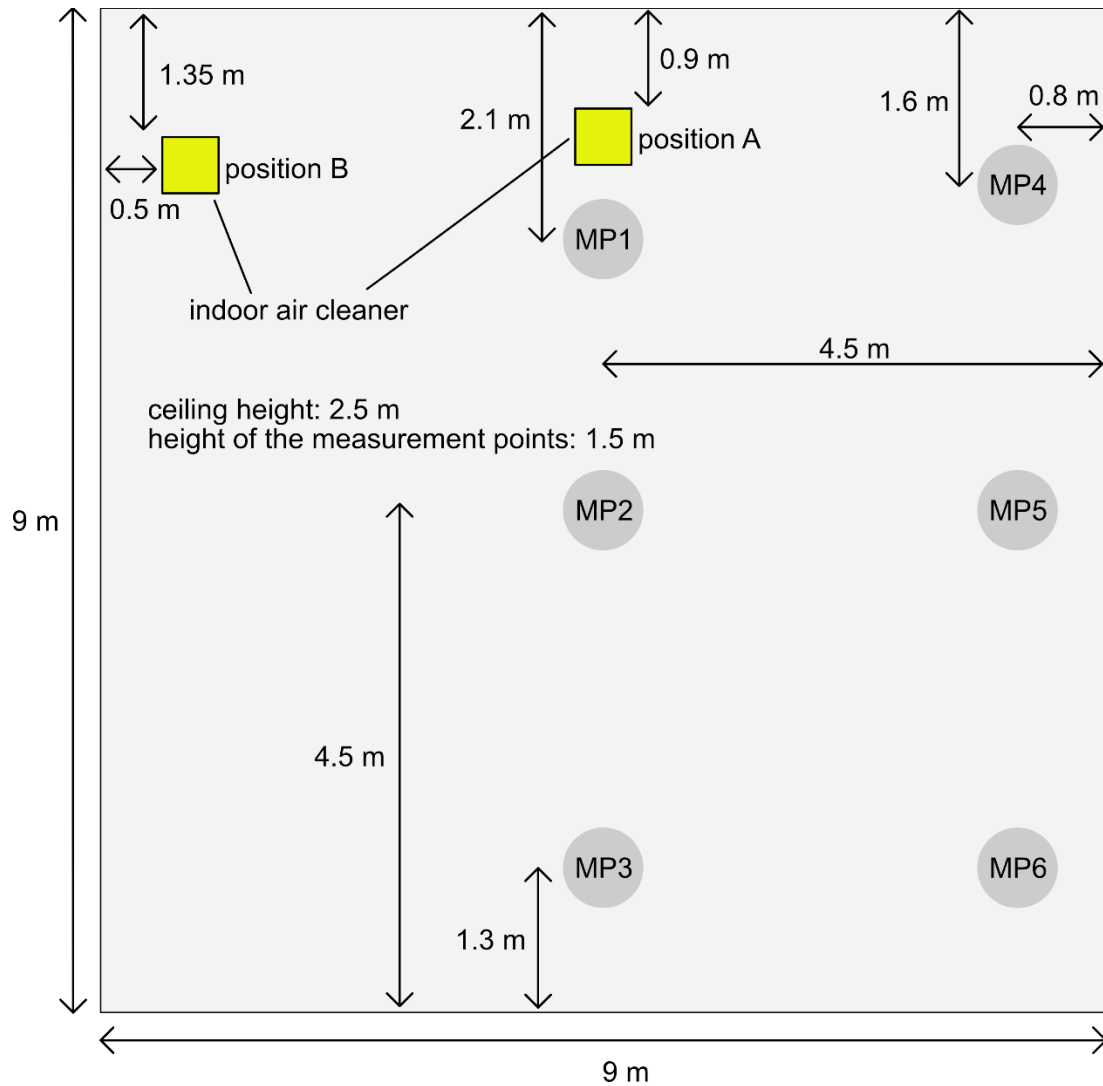

Figure 13: Arrangement of the components in the room for concentration measurements

## 6. Results of the concentration measurements

Using the test set-up used in section 2, the aerosol particle separation efficiency at the outlet of the unit was first verified visually. For this purpose, the entire room was homogeneously nebulized with DEHS aerosol particles with a diameter of  $0.1 - 2 \mu\text{m}$  and an average diameter of approx.  $1 \mu\text{m}$  [19]. With the help of a laser light-sheet in the area of the outflow it was measured whether aerosol was still coming out of the outlet area of the unit. Figure 14 shows that the free jet emerging at the upper corner of the room air purifier is free of aerosol at the different volume flows (black area). The performance of the Class H14 filter is therefore clearly visible even at high volume flows. The turbulent structure of the free jet and the entrainment, i.e. the mixing of aerosol into the clean free jet, is also clearly visible [24]. This entrainment or mixing effect is very important for an efficient transport of the aerosol to the intake area of the room air cleaner. The area surrounding the free jet, on the other hand, is completely contaminated with aerosol particles (white areas). The high concentration outside the free jet illustrates the average aerosol particle concentration in the room generated for the measurements.

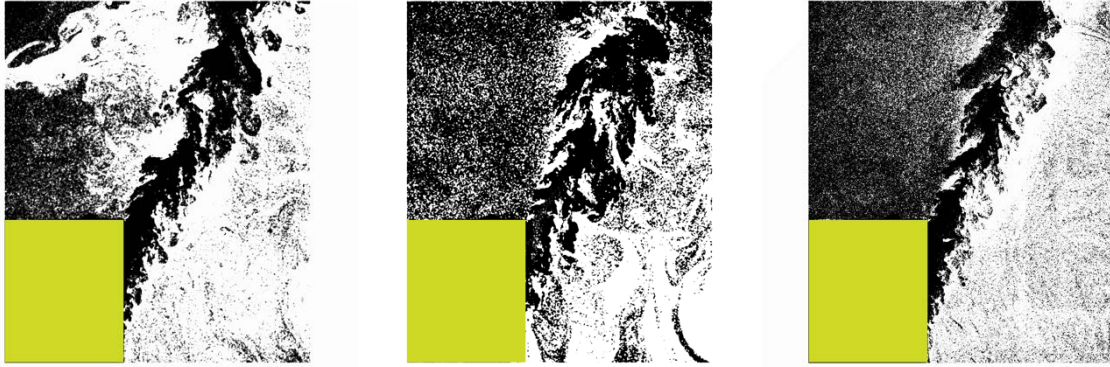

Figure 14: Representation of the aerosol distribution in the outflow area at a volume flow of  $1000 \text{ m}^3/\text{h}$

Figure 15 shows an example of the course of the aerosol particle concentration over time. The left Figure shows the concentration with the room air purifier switched off as a reference. Since all openings in the room have been sealed tightly and the aerosol particles hardly settle at all, the concentration is largely constant over the considered measuring time, so that an influence of natural deposition processes on the concentration measurements during measurements with the device switched on is not affected. In addition, tests were carried out with the unit running without F7 and H14 filters. The fact that the decay in particle concentration is slightly greater than in the case without operation of the room air cleaner is due to the fact that a very small amount of aerosol particles are separated in the fan due to centrifugal forces. However, a liquid film could not be detected on the fan or in the housing of the blower.

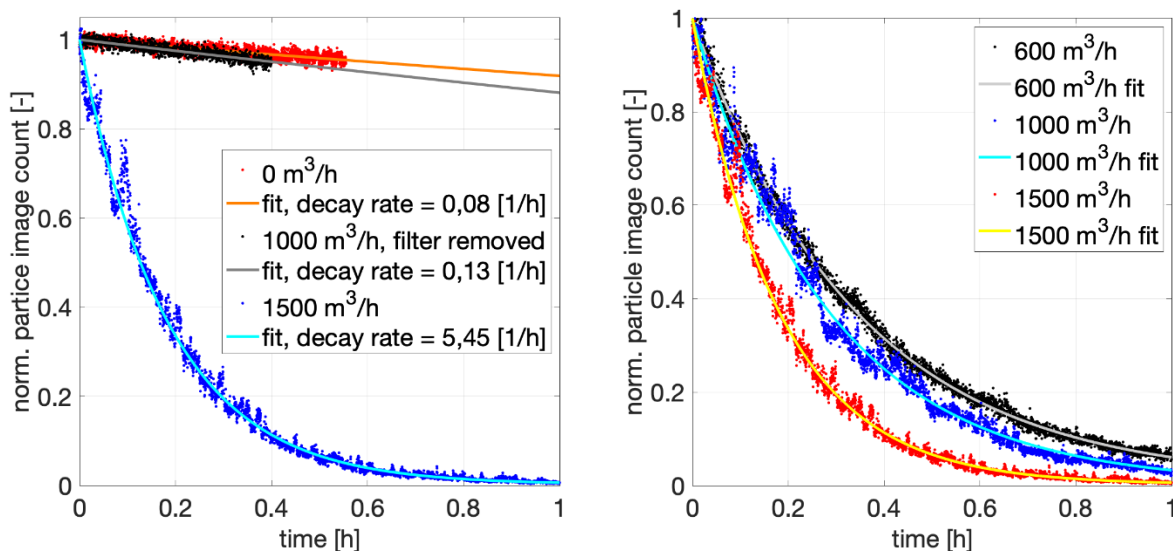

Figure 15: Decrease of aerosol concentration over time for different volume flows and associated exponential fit functions

The results clearly show that small long-lived droplet nuclei or droplets remain in the air almost permanently under conditions where the evaporation rate is in equilibrium with the condensation rate. The values given for the decay times in Figure 15 (left) make it possible to estimate how long it takes for the concentration to reach a desired value due to settling or rejection phenomena at walls. Due to the very small decay constant it is clear that the aerosol

can cause infections for many hours if it is not filtered out or if the temporal deactivation of the viruses makes an infection unlikely.

It is also obvious that the aerosol particles, since they do not evaporate completely, can be transported over very long distances (in principle many kilometres) by the air flow. However, it must be taken into account that during this transport the concentration and thus the probability of infection decreases enormously due to two processes. On the one hand, turbulent diffusion ensures spatial dispersion of the aerosol, which also occurs when the average flow velocity is zero. On the other hand, the aerosol released over a period of time is spatially strongly stretched and therefore diluted if the average flow velocity is not zero. For example, if 1 litre of air is exhaled over a period of 2 seconds during light physical exertion and the surrounding air has a velocity of 1 m/s, then the exhaled aerosol is stretched over a range of 2 m due to the flow. The concentration will therefore mathematically decrease by a factor of 20 and thus the viral load in the wake of the person from whom the aerosol is exhaled. For example, if viruses are exhaled by a cyclist riding at a speed of 10 m/s, the virus load in the wake will be diluted by a factor of 200 based on the speed alone. If turbulent diffusion is also taken into account, the concentration decreases by at least 1–2 orders of magnitude. In addition, not all aerosol particles carry viruses, see chapter 8. In the open air, an aerosol infection is therefore extremely unlikely if the wind speed is sufficient or the person moves.

Figure 15 (right) shows the decrease of the aerosol concentration in the 80 m<sup>2</sup> room as a function of time and the volume flow of the room air cleaner. The very efficient decrease of the concentration within a few minutes shows the efficiency of the F7 / H14 filter combination in connection with the volume flow of the room air cleaner. The exponentially decreasing course of the aerosol concentration makes it possible to quantitatively determine characteristic quantities which are essential for the evaluation of the filter performance. The decay constant is a measure for the efficiency of the filtration. The higher the value, the better the filter effect and the shorter the time required to filter the room air. The half life indicates how long it takes for the aerosol concentration at the point of measurement to decrease to half. The mean residence time characterizes how long the aerosol emitted at the respective measuring positions statistically remain in the room until they are separated by the air cleaner.

*Table 1: Decrease in aerosol concentration over time for different volume flows. Decay rate (black), half-life (green) and mean residence time (blue).*

Measuring position	600 m <sup>3</sup> /h (Position A)	1000 m <sup>3</sup> /h (Position A)	1500 m <sup>3</sup> /h (Position A)	1000 m <sup>3</sup> /h (Position B)
MP1	3,30   0,21   0,30	4,13   0,17   0,24	6,06   0,11   0,17	3,35   0,21   0,30
MP2	3,04   0,23   0,33	3,86   0,18   0,26	5,95   0,12   0,17	3,04   0,23   0,33
MP3	2,90   0,24   0,34	3,48   0,20   0,29	5,48   0,13   0,18	3,22   0,22   0,33
MP4	3,11   0,22   0,32	4,03   0,17   0,25	6,16   0,11   0,16	3,47   0,20   0,29
MP5	3,05   0,23   0,33	3,82   0,18   0,26	6,05   0,11   0,17	3,25   0,21   0,31
MP6	2,86   0,24   0,35	3,65   0,19   0,27	5,62   0,12   0,18	2,95   0,24   0,34
Decay rate [1/h]   Half-life [h]   Mean residence time [h]				

The filter performance is strongly dependent on the volume flow of the room air cleaner, but despite the size of the room, only slightly dependent on the distance to the unit. At 600 m<sup>3</sup>/h, the aerosol concentration is halved at position 1 after about 12 minutes and at the furthest position 6 after about 14 minutes. At a volume flow of 1500 m<sup>3</sup>/h, halving the aerosol concentration at position 1 takes about 6 minutes and 7 minutes at position 6.

For comparison, the right-hand column shows the values for a volume flow of 1000 m<sup>3</sup>/h for position B of the room. In comparison with the results at position A for the same volume flow, there is an impairment of the filter performance of about 20%. A poor position can therefore be compensated for by a higher volume flow, but then the energy requirement is greater and the noise development higher for the same filter performance. Therefore, the choice of position is definitely an important point.

In Table 2, a loaded and a new filter of Class H14 were measured comparatively. Taking into account the measurement uncertainty of  $2\sigma=0.14$  [1/h], no significant difference can be found between the two filters. It is therefore to be expected that the filters can have a service life of several years, depending on the load.

Table 2: Comparison between a loaded (used) and an unloaded (new) H14 filter

Measuring position	1000 m <sup>3</sup> /h (Position A), used filter	1000 m <sup>3</sup> /h (Position A), new filter
MP1	4,13   0,17   0,24	4,22   0,16   0,24
MP2	3,86   0,18   0,26	3,75   0,18   0,27
MP3	3,48   0,20   0,29	3,50   0,20   0,29
MP4	4,03   0,17   0,25	4,09   0,17   0,24
MP5	3,82   0,18   0,26	3,82   0,18   0,26
MP6	3,65   0,19   0,27	3,60   0,19   0,28
Decay rate [1/h]   Half-life [h]   Mean residence time [h]		

## 7. Dependence of the filter performance on the room geometry

The filter performance not only depends on the unit and the installation site, but also on the geometry of the room. Long rooms in particular are more difficult to filter because the jet on the ceiling eventually detaches and then a recirculation area forms that does not reach the opposite wall. This situation is comparable to the situation in Figure 11 (right) where the detachment of the flow from the ceiling is not caused by an object but by the reduction of the impulse of the wall jet with increasing distance. The reduction of the impulse is caused by the wall friction, the turbulent air movement and the entrainment, which can be seen very clearly in Figure 14. Especially the entrainment accelerates slow flow areas with aerosol through the filtered wall jet and the work required for this leads to a reduction of the wall jet momentum. The turbulence primarily leads to a widening of the jet, which also leads to a local decrease of the momentum and therefore shifts the flow-separation position of the wall jet closer to the unit. Due to these effects it is possible that the front area of the room is filtered very well, but the rear area is not. To investigate this situation generically, measurements were made in an elongated room with a cross-sectional area of approx. 4 m<sup>2</sup>. Two different room lengths were investigated: 22.4 m (experimental setup see Figure 16) and 11.8 m (Figure 17).



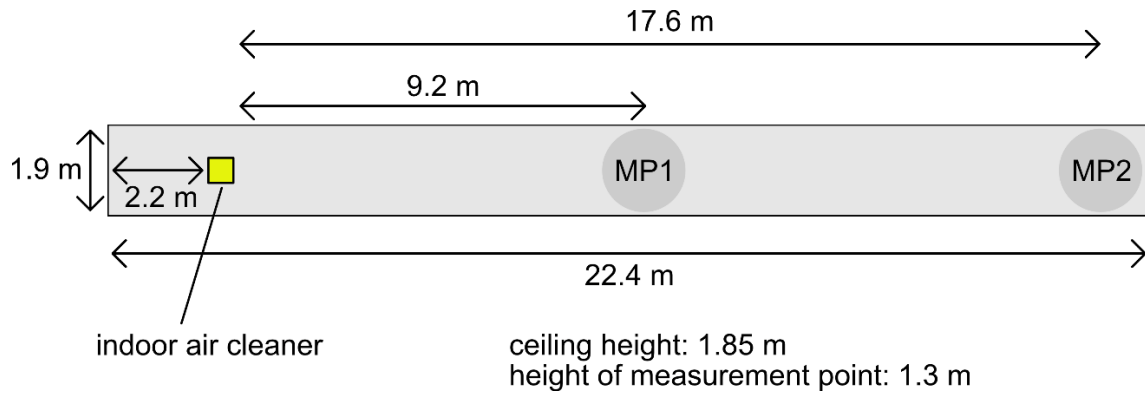

Figure 16: Arrangement of the components in the long corridor configuration for concentration measurements

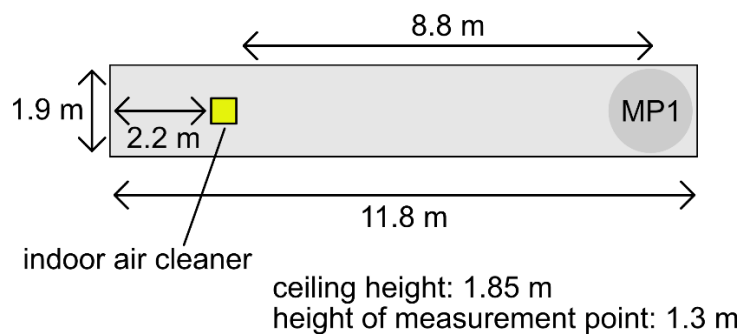

Figure 17: Arrangement of the components in the short corridor configuration for concentration measurements

The quantities determined from the concentration measurements are shown in Tables 3 and 4. It can be clearly seen that even in these elongated rooms a fairly fast separation of the aerosol is achieved. Even at the far measuring point MP2 in the long configuration a clear aerosol decrease can be observed, which corresponds approximately to the decrease at position MP1. As expected, the aerosol is removed faster in the short corridor configuration. It follows from this analysis that for very long rooms the use of two room air cleaners at the respective ends may be recommended.

Table 3: Decrease of aerosol concentration in the long corridor configuration over time for different volume flows. Decay rate (black), half-life (green) and mean residence time (blue).

Volume flow	MP1	MP2
600 m <sup>3</sup> /h	4,21   0,16   0,24	3,98   0,17   0,25
1000 m <sup>3</sup> /h	4,83   0,14   0,21	4,49   0,15   0,22
1585 m <sup>3</sup> /h	6,98   0,10   0,14	7,33   0,09   0,14
	Decay rate [1/h]   Half-life [h]   Mean residence time [h]	

*Table 4: Decrease in aerosol concentration in the short corridor configuration over time for different volume flows. Decay rate (black), half-life (green) and mean residence time (blue).*

Volume flow	MP1
600 m <sup>3</sup> /h	7,37   0,09   0,14
1000 m <sup>3</sup> /h	9,91   0,07   0,10
1585 m <sup>3</sup> /h	14,57   0,05   0,07
Decay rate [1/h]   Half-life [h]   Mean residence time [h]	

## 8. Comparison of the separation rate of the class F7 and H14 filter

HVAC systems for fine dust separation with high air purity are usually not equipped with class H14 filters, but often only with class F7 filters. The question therefore arises as to whether a class F7 filter is sufficient to reliably and efficiently separate aerosol generated when breathing, speaking, singing, coughing and sneezing. In [23] it is claimed that with double filtration of the room air with a class F7 filter, a total of 99% of airborne bacteria and viruses are removed from an air stream. SARS-CoV-2 is about 0.15  $\mu\text{m}$ , but since it is transmitted either by droplets or droplet nuclei, separation efficiencies in the range 0.3 – 1  $\mu\text{m}$  should be considered. The collection efficiency of a class H14 filter is 99.995% for particles with a diameter in the range of less than 0.3  $\mu\text{m}$  and almost 100% for all larger diameters. For a class F7 filter, it is 40 – 65% in the range 0.3 – 1  $\mu\text{m}$  and even less in the range smaller than 0.3  $\mu\text{m}$ . Even a tenfold filtering of the aerosol with a class F7 filter gives a worse separation result than a simple filtering with a class H14 filter. The assumption that a large volume flow with an F7 filter leads to comparable results as an H14 filter with a small volume flow is therefore not plausible for the size class under consideration. It must also be taken into account that the separation of small particles is based on physical mechanisms that only work efficiently if the flow velocity in the filter is low. A significant increase in the volume flow rate is therefore only advisable if the total surface area of the filter is also increased. A high volume flow inevitably also leads to a high air velocity in the room and this can be unpleasant according to Figure 2. Furthermore, noise also increases with the air speed. Finally, it must be taken into account that a high air velocity in the ventilation ducts leads to an increase in losses and thus the energy requirement increases. On the other hand, the flow resistance of a class F7 filter is significantly lower than that of a class H14 filter, which speaks in favour of the class F7 filter. In order to be able to compare the filter performance of the two filters, tests were carried out at a volume flow rate of 1000 m<sup>3</sup>/h in the room shown in Figure 17.

The results of the investigation show that the half-life for the F7 + H14 configuration is 4.2 minutes, for the F7 filter alone 10.2 minutes and 64 minutes without filter, see Table 5. The analysis shows that an HVAC system with class F7 filters achieves good separation efficiencies with multiple filtration and therefore an existing HVAC system should be operated with class F7 or better filters. Since aerosol particles with a diameter in the submicron range cannot be efficiently removed with the class F7 filter, the fresh air portion should be selected as large as possible to compensate for the considerable disadvantage compared to the class H14 filter in the separation of the small aerosol particles.

If fast and highly efficient filtering is required that reliably filters out even the smallest aerosol particles with high efficiency and small volume flow, then a class H14 filter is recommended. In areas that do not have air handling units and are not too voluminous, mobile room air filters offer a very good possibility to remove the aerosol in the room without the disadvantages of free ventilation.

*Table 5: Decrease in aerosol concentration in the short corridor configuration over time for different filter configurations. F7 + H14, only F7, no filters, device switched off. Decay rate (black), half-life (green) and mean residence time (blue).*

Volume flow	MP1
1000 m <sup>3</sup> /h (F7 + H14)	9,91   0,07   0,10
1000 m <sup>3</sup> /h (only F7)	4,15   0,17   0,24
1000 m <sup>3</sup> /h (no filter)	0,65   1,07   1,54
0 m <sup>3</sup> /h	0,66   1,05   1,52
Decay rate [1/h]   Half-life [h]   Mean residence time [h]	

## 9. Consideration of virus-laden particles and their infectivity

Within the scope of this study, primarily the separation of aerosol particles with a diameter in the range of 0.3–2  $\mu\text{m}$  was considered, since this size is physically difficult to separate on the one hand and because on the other hand this size is particularly relevant for SARS-CoV-2 infections from our point of view. When considering the aerosols potentially considered dangerous, 2 facts must be considered. As explained at the beginning, a distinction must be made between the wet and dry state of the aerosol particles. If the particles are produced in the lungs or the respiratory tract, they are initially wet, i.e. the solids (salts, proteins, ...) and any viruses present are in an aqueous environment. If these wet aerosol particles leave the body, the aqueous phase evaporates in a short time when the air humidity is moderate. For small particles with diameters in the range of a few micrometers, this happens within fractions of a second at low ambient humidity [6]. What remains are solid droplet nuclei with only a very low water content. If we assume for simplicity's sake that all the water evaporates, the diameters of the dry aerosol particles shown in Figure 18 are based on the wet aerosol particles. Three curves are shown for different typical solid mass fractions of 1, 3 and 5% [31]. The density of water was assumed to be 1000 kg/m<sup>3</sup>, the density of the solids 1300 kg/m<sup>3</sup>.

The diameter of the aerosol particles released is usually in the range of less than 10  $\mu\text{m}$ , with the maximum of the size distribution being approximately 1  $\mu\text{m}$  [32, 33]. For a direct infection, diameters in this range are relevant, but for an indirect infection, the diameters readable from Figure 18 must be taken into account for the respective solid contents. The latter are also relevant for filtering at moderate humidity. The size of the aerosol that must be separated is therefore in the range 0.3–3  $\mu\text{m}$  according to Figure 18, whereby according to this calculation sizes around 0.3  $\mu\text{m}$  make up the majority of the aerosol after evaporation. According to this consideration, the aerosol size distribution primarily considered by us in this study is of high relevance with regard to SARS-CoV-2 infection if the droplet nuclei are found to be infectious.

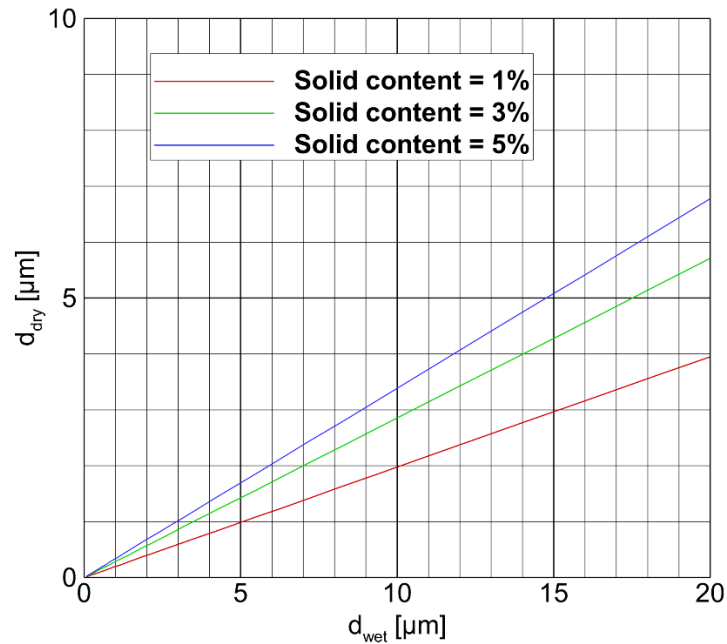

Figure 18: Diameter of dried aerosols as a function of the initial diameter of wet aerosols for 3 different solid mass fractions

Furthermore, the question arises how high the probability is that an aerosol particle contains a virus at all. For this purpose, a simple estimation was performed, whereby the virus concentration [viruses/ml] was related to the number of aerosol particles per volume [droplets/ml] at a certain aerosol diameter. The result of this consideration is shown in Figure 19. The probabilities are given for 4 different virus concentrations resulting from [34]. According to these investigations,  $7 \times 10^6$  viruses/ml were an average virus concentration and  $2.35 \times 10^9$  viruses/ml were the maximum virus concentration in the respiratory mucosa. It can be seen that especially small aerosols have only a low probability of transporting a virus. Not every aerosol particle released by an infected person is therefore infectious.

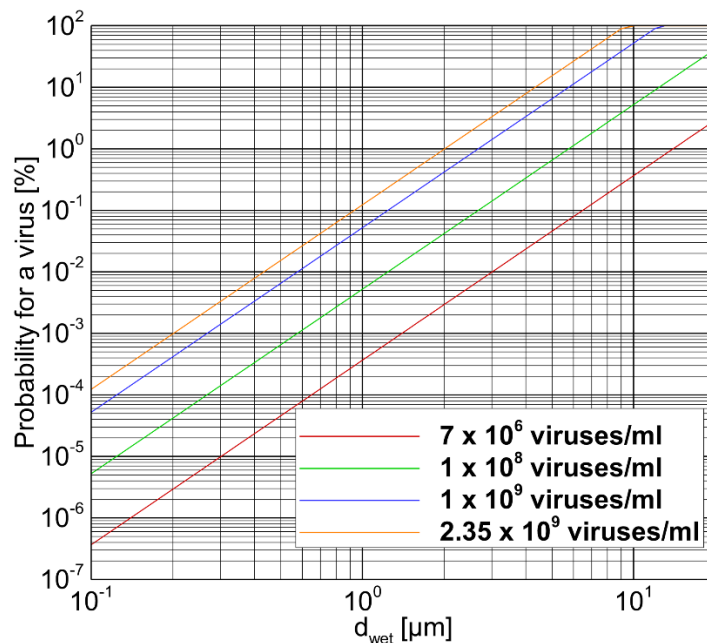

Figure 19: Result of a simple estimation of the probability that a wet aerosol contains a virus

If it is further assumed that a dry aerosol has a diameter of 1  $\mu\text{m}$ , Figure 18 shows that with a solid content of 1%, the diameter of the wet particle is 5  $\mu\text{m}$ . At a virus concentration in the respiratory mucosa of  $1 \times 10^9$  viruses/ml, this results in a probability that this aerosol contains a virus of about 7%. Thus, only about every 14th aerosol particle is infectious. On the other hand, it is precisely the small aerosols in the room air that predominate by far, so that they cannot be neglected, especially if people spend a long time in a room contaminated with infectious aerosol particles. Therefore a very good and efficient separation of the small diameter aerosol or a good supply of fresh air to dilute the viral load in the room is very important to minimize the indirect risk of SARS-CoV-2 infection.

## 10. Summary and conclusion

The quantitative measurement results show that with the tested TROTEC TAC V+ room air cleaner, due to the large volume flow and the filter combination of class F7 + H14, the aerosol particle concentrations can be halved in 6–15 minutes, depending on the volume flow, in rooms with a surface area of 80  $\text{m}^2$ . In rooms with a surface area of 20  $\text{m}^2$ , halving is achieved in 3–5 minutes, depending on the volume flow rate. It is therefore possible with room air cleaners to keep the aerosol concentration in small and medium-sized rooms at a low level without any problems.

Even in a 22 m long, corridor-like room with more than 40  $\text{m}^2$ , a halving of the aerosol concentration could be realised within about 5 minutes at maximum volume flow. In larger rooms, rooms with many objects or very unfavourable geometries, several air purifiers should be used if necessary in order to filter all areas of the room quickly. Due to the dangerousness of the SARS-CoV-2 infection, the air exchange rate should, in our opinion, reach at least values in the range 4–8.

To enable the most effective filtering of the room air, the room air cleaner should be positioned in the middle of the longest side of the room if possible. In addition, the ceiling area should not be interrupted by objects in the direction of the outflows, if possible, as otherwise the spread of the wall jets is disturbed and an unfavourable vortex can develop in the room. If operating conditions are unfavourable, the volume flow rate should be increased to ensure adequate filter performance. It is also recommended that the unit be operated in continuous operation and not intermittently, so that no increased virus concentration can develop in the room.

Powerful room air cleaners with class F7 + H14 filter combination can keep the aerosol concentration in small and medium-sized rooms at a low level and therefore the indirect risk of infection can be greatly reduced by these units, even with closed windows and without a suitable air conditioning system. They are therefore very well suited to permanently ensure a low viral load in classrooms, shops, waiting or treatment rooms, for example, without having to worry about opening windows and impairing the well-being in the room. Furthermore, in contrast to free ventilation with windows, they also ensure that there is a real reduction in the virus load, which often cannot be guaranteed with free ventilation. They also offer the advantage over HVAC systems that are operated with little or no fresh air, that the viruses are really eliminated and are not distributed via other channels in the building.

For hygienic reasons, the tested room air cleaner is able to decontaminate the H14 filter by heating it to about 100°C. If this happens daily for about 30 minutes, the viruses in the filter are deactivated and the formation of biofilms, bacteria and fungi can be prevented without harmful chemical additives or UV-C radiation.

Finally, it should be emphasized that although room air purifiers, open windows and powerful air handling units are suitable tools to counteract the indirect risk of infection, they cannot reduce the direct risk of infection, which can occur through direct coughing or during long conversations over short distances. It is therefore important to maintain sufficient distance from other people and to wear mouth-and-nose masks or particle-filtering respirators to prevent direct infection.

## Note

The investigations were financially supported by the company TROTEC GmbH, Heinsberg, Germany. The TAC V+ room air cleaner was provided by TROTEC for the investigations. The investigations were carried out in accordance with good scientific practice. The support provided by TROTEC has no effect on the results presented.

## Literature

- [1] Jayaweera M, Perera H, Gunawardana B, Manatunge J (2020) Transmission of COVID-19 virus by droplets and aerosols: A critical review on the unresolved dichotomy. *Environ Res.* 2020 Sep; 188: 109819. <https://doi.org/10.1016/j.envres.2020.109819>
- [2] Morawska L, Cao J (2020) Airborne transmission of SARS-CoV-2: The world should face the reality. *Environment International*, Volume 139, 105730
- [3] Zhang R, Lib Y, Zhang AL, Wang Y, Molina MY (2020) Identifying airborne transmission as the dominant route for the spread of COVID-19. *PNAS* (2020), 10.1073/pnas.2009637117, first published June 11
- [4] Lu J et al. (2020) COVID-19 Outbreak associated with air conditioning in restaurant, Guangzhou, China, 2020. *Emerging Infectious Diseases*, [www.cdc.gov/eid](http://www.cdc.gov/eid), Vol. 26, No. 7, DOI: <https://doi.org/10.3201/eid2607.200764>
- [5] Kähler CJ, Hain R (2020) Fundamental protective mechanisms of face masks against droplet infections. *Journal of Aerosol Science* 148:105617, <https://doi.org/10.1016/j.jaerosci.2020.105617>
- [6] Kähler CJ, Hain R (2020) Strömungsanalysen zur SARS-CoV-2 Schutzmaskendebatte. <https://www.unibw.de/lrt7/stroemungsanalysen-zur-sars-cov-2-schutzmaskendebatte>  
<https://youtu.be/SM2QrPFC3MY>
- [7] Kähler CJ, Hain R (2020) Musizieren während der Pandemie - was rät die Wissenschaft? <https://www.unibw.de/lrt7/musizieren-waehrend-der-pandemie>  
<https://youtu.be/0JmcjRhV-rs>
- [8] Wells WF, M.W. Wells MW (1936) Air-borne infection. *Journal A. M. A.*, Cambridge, pp. 1698–1703
- [9] Soper GA (1919) The lessons of the pandemic. *Science*, 49, pp. 501–506
- [10] Fernstrom A, Goldblatt M (2013) Aerobiology and its role in the transmission of infectious diseases. *Journal of Pathogens*, Volume 2013, article ID 493960, <http://dx.doi.org/10.1155/2013/493960>
- [11] Doremalen van N, Bushmaker T, Morris DH, Holbrook MG, Gamble A, Williamson BN, Tamin A, Harcourt JL, Thornburg NJ, Gerber SI, Lloyd-Smith JO, de Wit E, Munster VJ

- (2020) Aerosol and surface stability of SARS-CoV-2 as compared with SARS-CoV-1. *New England Journal of Medicine* 382:1564–1567, <https://doi.org/10.1056/NEJMc2004973>
- [12] Pyankov OV, Bodnev SA, Pyankova OG, Agranovski IE (2018) Survival of aerosolized coronavirus in the ambient air. *Journal of Aerosol Science* 115:158–163, <https://doi.org/10.1016/j.jaerosci.2017.09.009>
- [13] Morawska L, Milton DK (2020) It is Time to Address Airborne Transmission of COVID-19. *Clinical Infectious Diseases*, ciaa939, <https://doi.org/10.1093/cid/ciaa939>
- [14] Klompas M, Baker MA, Rhee C (2020) Airborne Transmission of SARS-CoV-2 - Theoretical Considerations and Available Evidence. *JAMA*. Published online July 13, doi:10.1001/jama.2020.12458
- [15] McKie R (2020) Did singing together spread coronavirus to four choirs? 17. May, *The Guardian / The Observer*, <https://www.theguardian.com/world/2020/may/17/did-singing-together-spread-coronavirus-to-four-choirs>
- [16] Heinz E (2016) *Wohnraumlüftung – frei und ventilatorgestützt*. Beuth Verlag GmbH, Berlin, Wien, Zürich
- [17] von Pettenkofer M (1858) *Besprechung allgemeiner auf die Ventilation bezüglich Fragen. Über den Luftwechsel in Wohngebäuden*. J.G. Cotta'sche Buchhandlung, München
- [18] DIN EN 16798 – Gebäude-Energieeffizienz mit LüKK-Systemen
- [19] VDI 2082 – Raumluftechnik Verkaufsstätten (VDI-Lüftungsregeln)
- [20] DIN 1946-4 – Raumluftechnik im Gesundheitswesen
- [21] Deutsche Gesellschaft für Krankenhaushygiene (2002) Leitlinienentwurf: Ausführung und Betrieb von raumluftechnischen Anlagen (RLT-Anlagen) in Krankenhäusern. *Hyg Med* 27. Jahrgang 2002 – Heft 3
- [22] Deutsche Gesellschaft für Krankenhaushygiene (2015) Krankenhaushygienische Leitlinie für die Planung, Ausführung und den Betrieb von Raumluftechnischen Anlagen in Räumen des Gesundheitswesens. *Hyg Med* 2015; 40 – 12
- [23] Fachverband Gebäude-Klima e. V. (2020) *Betrieb Raumluftechnischer Anlagen unter den Randbedingungen der aktuellen Covid-19-Pandemie*. 03.08.2020, Version 3, [www.fgk.de/images/Aktuelles/2020/08-20/RLT\\_Covid19\\_V3\\_200803.pdf](http://www.fgk.de/images/Aktuelles/2020/08-20/RLT_Covid19_V3_200803.pdf)
- [24] Etheridge D, Sandberg M (1996) *Building Ventilation: Theory and Measurement*. Wiley ISBN: 978-0-471-96087-4
- [25] Etheridge D (2011) *Natural Ventilation of Buildings: Theory, Measurement and Design*. Wiley ISBN: 978-0-470-66035-5
- [26] DIN 1946 Teil 2 (1994) *Raumluftechnik: Gesundheitstechnische Anforderungen (VDI-Lüftungsregeln)*
- [27] <https://de.trotec.com/produkte-services/maschinen-highperformance/luftreinigung/raumluftreiniger-tac-v/>
- [28] Raffel M, Willert CE, Scarano F, Kähler CJ, Wereley ST, Kompenhans J (2018) *Particle Image Velocimetry: a practical guide*. Springer, 3. Auflage, ISBN-10: 9783319688510

- [29] Kähler CJ, Sammler B, Kompenhans J (2002) Generation and control of tracer particles for optical flow investigations in air. *Experiments in Fluids* 33:736–742
- [30] Küpper M, Asbach C, Schneiderwind U, Finger H, Spiegelhoff D, Schumacher S (2019) Testing of an indoor air cleaner for particulate pollutants under realistic conditions in an office room. *Aerosol and Air Quality Research* 19:1655–1665, doi: 10.4209/aaqr.2019.01.0029
- [31] Stadnytskyi V, et al. (2020) The airborne lifetime of small speech droplets and their potential importance in SARS-CoV-2 transmission. *PNAS* 117:11875–11877
- [32] Lee J, Yoo D, Ryu S, Ham S, Lee K, Yeo M, Min K, Yoon C (2019) Quantity, size distribution, and characteristics of cough generated aerosol produced by patients with an upper respiratory tract infection. *Aerosol and Air Quality Research*, 19, pp. 840–853
- [33] Johnson GR, Morawska L, Ristovski, ZD, et al. (2011) Modality of human exposed aerosol size distributions. *Journal of Aerosol Science* 42:839–851
- [34] Wölfel R, et al. (2020) Virological assessment of hospitalized patients with COVID-2019. *Nature* 581:465–469